

NP12-20Ah 12V20Ah



Specifications

Nominal Voltage		12V
Rated capacity (20 hour rate)		20Ah
Dimensions	Length	181±2mm(7.13inch)
	Width	77±1mm(3.03inch)
	Height	167±2mm(6.57inch)
	Total Height	167±2mm(6.57inch)
Approx. Weight		5.5kg(12.1lbs)±4%

Outer dimensions (mm)

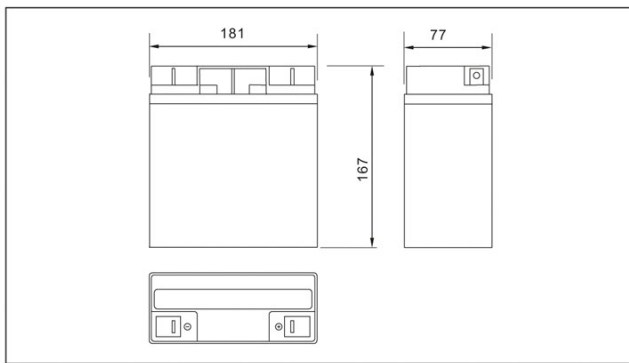

Terminal Type (mm)

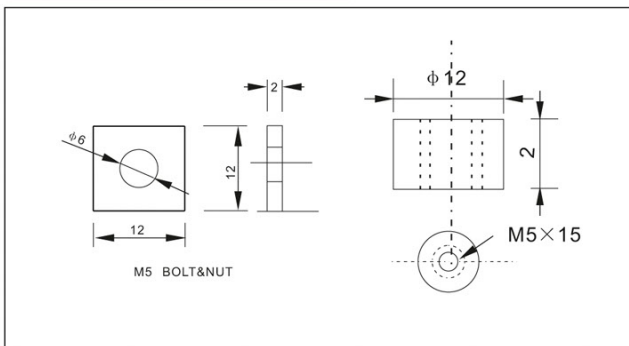

Characteristics

Capacity (25°C)	20HR(10.5V)	20Ah
	10HR(10.5V)	18.5Ah
	1HR(9.60V)	12Ah
Terminal type		T3/T12
Internal resistance (Fully charged,25°C)		Approx.12m Ω
Capacity affected by temperature (20HR)	40°C	102%
	25°C	100%
	0°C	85%
	-15°C	65%
Self-discharge (25°C)	3month	Remaining Capacity:91%
	6month	Remaining Capacity:82%
	12month	Remaining Capacity:65%
Nominal operating temperature		25°C ±3°C(77°F ±5°F)
Operating temperature range	Discharge	-15°C~50°C(5°F~122°F)
	Charge	-10°C~50°C(14°F~122°F)
	Storage	-20°C~50°C(-4°F~122°F)
Float charging voltage(25°C)		13.50 to 13.80V Temperature compensation: -18mV/°C
Cyclic charging voltage(25°C)		14.50 to 15.00V Temperature compensation: -30mV/°C
Maximum charging current		6A
Maximum discharge current		300A(5 sec.)
Designed floating life(20°C)		5 years

Construction

Component	Positive plate	Negative plate	Container	Cover	Separator	Electrolyte	Safety valve	Terminal
Raw material	Lead dioxide	Lead	ABS	ABS	AGM	Sulfuric acid	Rubber	Copper

Constant Current Discharge Characteristics Unit:A(25°C,77°F)

F.V/Time	5min	10min	15min	30min	60min	2h	3h	4h	5h	10h	20h
9.60V	76.4	48.4	37.8	21.3	13.1	7.17	4.96	4.10	3.49	1.89	1.02
9.90V	74.1	46.9	36.9	20.9	12.9	7.12	4.93	4.08	3.47	1.89	1.01
10.2V	71.1	45.0	35.5	20.2	12.6	7.06	4.89	4.05	3.44	1.88	1.01
10.5V	68.0	43.1	34.3	19.7	12.3	6.95	4.86	4.02	3.42	1.87	1.00
10.8V	64.2	40.7	32.5	19.0	11.9	6.78	4.71	3.90	3.32	1.83	0.98

Constant Power Discharge Characteristics Unit:W(25°C,77°F)

F.V/Time	5min	10min	15min	30min	60min	2h	3h	4h	5h	10h	20h
9.60V	853	546	431	244	152	83.8	58.9	48.8	41.7	22.7	12.2
9.90V	827	530	421	239	149	83.3	58.5	48.5	41.4	22.6	12.1
10.2V	793	508	405	232	146	82.6	58.1	48.2	41.1	22.5	12.1
10.5V	759	486	391	226	143	81.4	57.7	47.9	40.8	22.4	12.0
10.8V	716	459	371	218	138	79.3	56.0	46.4	39.6	21.9	11.8

Note: The above characteristics data can be obtained within three charge or discharge cycles.

NP12-20Ah 12V20Ah

● Discharge characteristics(25°C)

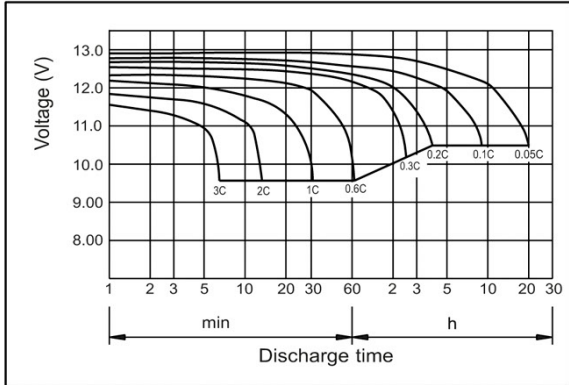

● Charging characteristics (25°C)

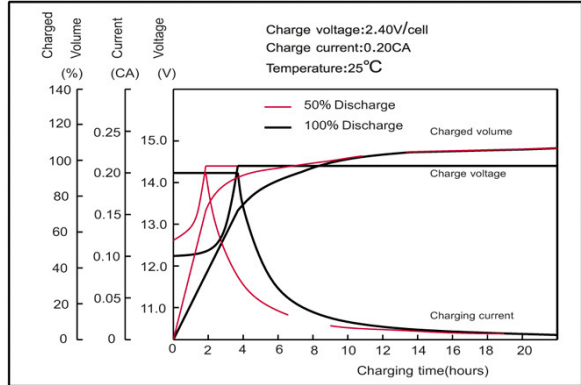

● Effect of temperature on capacity

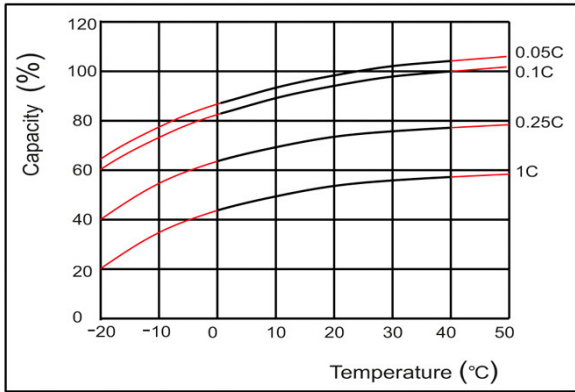

● Self-discharge characteristics

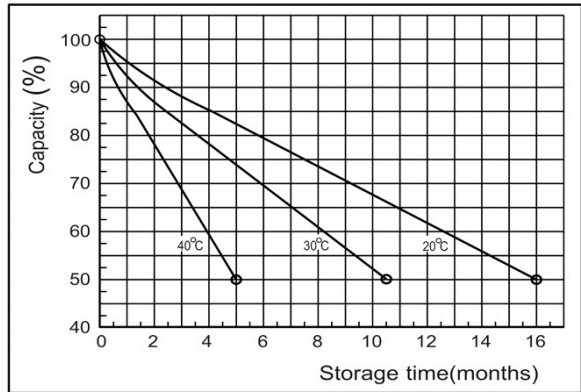

● Floating life on temperature

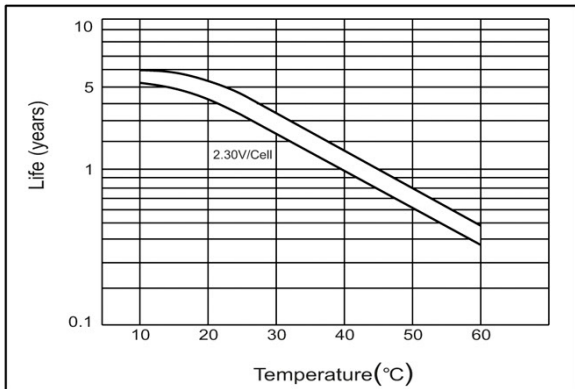

● Cycle life on D.O.D(25°C)

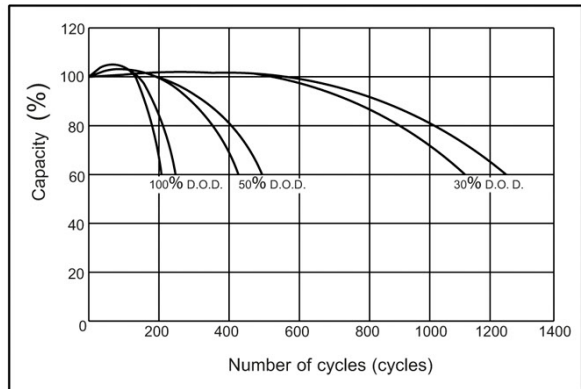

● The relationship for OCV and Capacity (25°C)

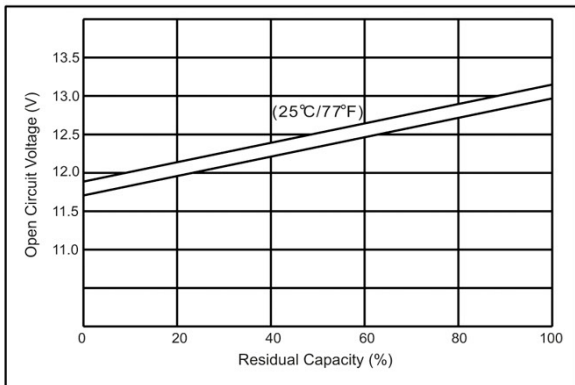

● The relationship for Charging voltage and Temperature

